

## RTK UC625

### Programmable alarm annunciator

- Alarm Sequence selectable to ISA S18.1-1979
- Available in a range of sizes from 12 to 40 ways
- Expansion units available to create larger systems
- Integral redundant supplies with universal inputs
- Two additional 'power failure' alarms with relay outputs
- Low Power Consumption
- Exclusive ASIC Technology for greater reliability
- Only 130 mm Installed Depth



#### An expandable compact alarm system

The RTK UC625 Alarm System, developed from the field proven P625 range of alarm annunciators, offers the latest in ASIC technology packed into a compact design for applications where panel space is at a premium.

The lightweight stainless steel construction gives a compact and simple to install modular unit which can easily be expanded by the addition of extra Alarm Cards.

Maintenance can be carried out live without the necessity of 'gas checks' or prior shutdown. Unlike explosionproof, purged and type 'n' systems, installation is simple and relatively low cost.

With the addition of a number of ancillary devices a complete intrinsically safe alarm and control package can be provided.

RTK UC625

March 2020

**FEATURES & BENEFITS**

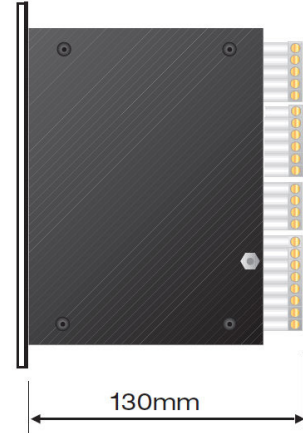
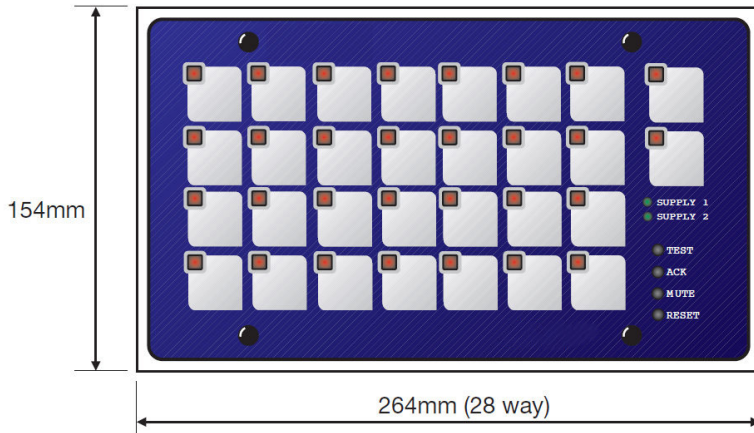

**Various Sizes**

Various sizes are available from 12 to 40 alarm points. Each unit is supplied with two additional alarm points for monitoring the two integral power supplies.

Dimensions are as follows:

NO. OF WAYS	OVERALL IN MM		CUT-OUT IN MM	
	HEIGHT	WIDTH	HEIGHT	WIDTH
12	154	152	141	136
16	154	180	141	164
20	154	208	141	192
24	154	236	141	220
28	154	264	141	248
32	154	292	141	276
36	154	320	141	304
40	154	348	141	332

**Fully Field Programmable**

Flexible design allows selection of a range of features and a choice of operational alarm sequences, which are compliant to ISA S18.1 1979. Alarms can be set to operate from either a normally open or a normally closed volt-free signal contact.

**ASIC Technology**

The RTK UC625 continues our success with field proven ASIC technology already employed in our range of alarm products, This gives the user both greater flexibility and reliability.

**Auxiliary Relays**

Each channel is equipped with an integral relay facility, typically used to initiate inputs to third party devices such as RTU, SCADA or DCS systems. On board DIL switches or jumpers allow the user to select the manner in which the relay responds; normally energised or de-energised relay state and if the contact is normally open or normally closed in the non-alarm state.

**Inputs**

All inputs are optically coupled and comply to the stringent requirements of the European Electromagnetic Compatibility and Low Voltage Directives. The standard input voltage is 24VDC but 48VDC,125VDC or 250VDC are available as an option.

**Integral Redundant Power Supplies**

In order to maintain the highest level of reliability in safety critical applications, all models are equipped with integrated dual power supplies. The standard unit is equipped with two fully isolated universal input supplies, each capable of accepting either 85-264VAC or 88-300VDC. As an option the secondary supply can be suitable for 24VDC if specified at the time of order.

**Field Contact Voltage Monitoring**

When using 24VDC the field contact voltage is supplied from the UC625. This supply is protected and fused and also monitored for failure. If this supply fails for any reason an output relay is tripped to warn operators that alarm information may be lost.

**Power Consumption**

Power consumption is kept to a minimum by the use of super-bright LEDs.

**Auto Accept Timer**

In unmanned applications it is common to have an automatic accept facility after a pre-set time, typically one minute; this is a standard feature on the UC625.

**Dual Horn Facility**

Two horn relays are fitted as standard and each pair of alarm ways can be selected to operate either a critical or non-critical integrally mounted horn relay. In substation applications it is common for one relay to be used to operate the externally mounted station bell and the second relay to be used to operate a common power failure audible alarm.

**Sleep Mode**

All units are equipped with 'Sleep' mode which is typically used in substation applications where the visual and audible outputs are disabled during unmanned periods to reduce drain on the station batteries. Whilst in 'Sleep' mode, the alarm logic will continue to react in the normal way including the operation of the group alarm relays and individual repeat and common alarm relays – ONLY the drive signals to the LEDs and the audibles are disabled until the unit is placed back into the 'Run' mode.

**Input Response**

As standard, the input response is set to 22ms for optimum performance, however this delay is user programmable and can be reduced or extended to suit the exact site conditions.

# RTK UC625

March 2020

## FEATURES & BENEFITS

### Film Legend Engraving

Because the exact text is often not known at the time of order, the UC625 has been developed to use acetate film legends which allows users to easily generate their own legends using a computer and laser printer.

### Connections

All connections are made on the rear of the unit using two-part quick disconnect rising clamp terminals accepting up to 2.5mm<sup>2</sup> cable. All terminals are lockable using the screws at each end of the terminal making it impossible for terminals to fall out or be removed inadvertently.

### Common Outputs

As standard, each unit is fitted with three common relays: Critical Audible Relay, Non-Critical Audible Relay and Common Alarm Relay. The common alarm relay is equipped with a reflash feature to indicate the occurrence of a new alarm within the unit.

### Power Failure Alarms

Two channels within the annunciator are reserved for power failure monitoring. One monitors the presence of the primary supply and the other monitors the presence of the auxiliary supply.

### Pushbutton Controls

Integral pushbuttons are provided for Functional Test, Acknowledge, Mute, and Reset which control the operation of the standard alarms within the instrument. The two power failure alarms have their pushbutton control lines wired to Customer terminals for connection to remote Functional Test, Accept and Reset pushbuttons. As an option, all alarms ways can be controlled from the integral pushbuttons.

### Illumination

The RTK UC625 is equipped with 8mm superbright red LEDs for increased reliability and minimal power consumption.

### IP Rating

Flush panel units are IP51 rated, optional IP54 weatherproof doors or IP56 wall mounted enclosures are available.

### Tropicalisation

In harsh environments where moisture or chemicals may be present in the atmosphere, there is an option to tropicalise the unit. This consists of spraying the unit with a conformal coating.

### Serviceability

All normal servicing and maintenance is carried out from the front of the unit without the need for special tools.



## SEQUENCE TABLES

AUTOMA TIC RESET Sequence Code A

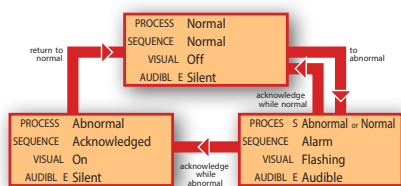

MANUAL RESET Sequence Code M

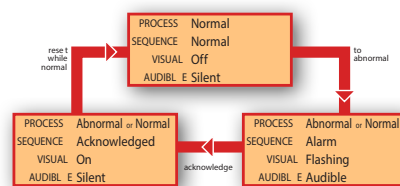

MANUAL RESET FIRST OUT WITH NO SUBSEQUENT ALARM FLASHING AND SILENCE PUSHBUTTON N

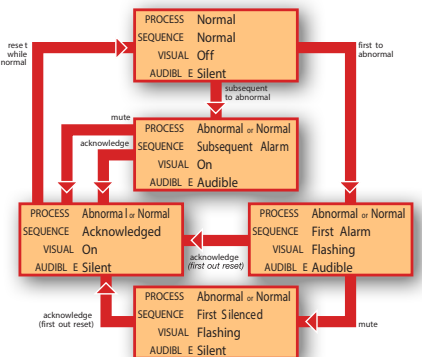

RINGBACK Sequence Code R

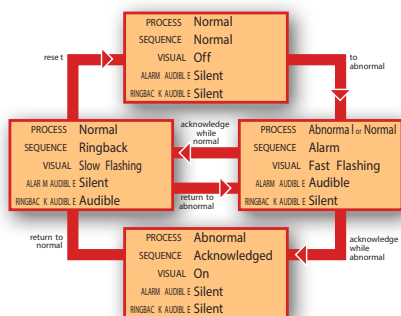

AUTOMA TIC RESET FIRST OUT WITH NO SUBSEQUENT ALARM STATE Sequence F1A

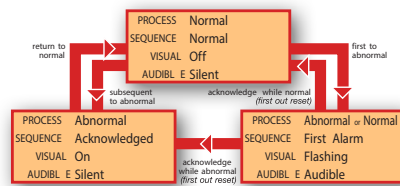

# RTK UC625

March 2020

## INPUTS

### Alarm Contacts

All inputs are optically coupled and can be used for volt free Normally Open or Normally Closed contact inputs. Voltage inputs can also be used, these can be 24, 48, 125 or 250VAC/DC.

### Alarm Contact and Cable Resistance

N/C contact-series resistance of contact cables 5k max.  
N/O contact-parallel resistance of contact cables 150k min.

### Surge Immunity

IEEE/ANSI C37.90.1  
IEC 61000-4-4, 2KV

### Input Response Time

The standard unit has a response time of 22ms. DIL switches are used to select alternative response times.

### First-up Discrimination

Better than 5ms.

### Input Protection

Inputs are protected against accidental connection to mains voltages (240VAC, 50Hz) or a 1000V Megger Test.

## OUTPUTS

### Visual

Back illumination by 8mm super-bright LEDs plus green Power On LED.

### Relays

Individual signal duplicating relays, contacts rated at 125VDC max, 24VDC @ 2A  
125VDC @ 100mA  
Horn and group relays, contacts rated at 125VDC max, 24VDC @ 2A  
125VDC @ 0.5A

### Audible

Two integral audibles are included as standard, which can be inhibited as required.



## SUPPLY

### Supply 1

Voltage range 85-264VAC or 88-300VDC.

### Supply 2

Voltage range 85-264VAC or 88-300VDC (Optional 24VDC).

## GENERAL

### Connections

Two part rising clamp terminals, for cables up to 2.5mm<sup>2</sup>.

### EMC Compliance

Immunity: EN61000-6-2:2005  
Emissions: EN61000-6-4:2007

## LVD Compliance

Compliant with EN61010-1:2010 and IEC61010-2-201

## Environment

Operating Temp 0 to +60°C  
Storage Temp -20 to +80°C  
Humidity 0-95% RH, non-condensing

## Protection

Front - IP51, Rear - IP20.  
The rear of the UC625 must be protected by an enclosure which is at least IP30 and secured by a tool or key

## Pushbuttons

Integrally mounted Functional Test, Acknowledge, Mute and Reset pushbuttons for all standard alarms. One set of terminals for the two "power failure" alarms pushbutton circuits.

## ORDER CODE

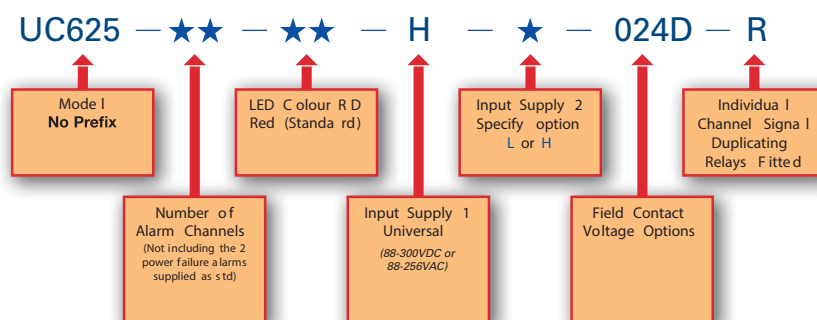

MODEL NO.	NO OF ALARMS	LED COLOUR	SUPPLY 1	SUPPLY2	FIELD CONTACT VOLTAGE	REPEAT RELAYS	
UC625	12	RD=Red YW=Yellow AM=Amber GN=Green WT=White IN=Intermixed	H=Universal 88 to 300VDC or 88 to 264VDC	OPTIONAL L=24VDC or H-UNIVERSAL 88 to 264VDC or 88 to 300VDC	Standard	R=Repeat Relay Option Fitted	
	16				024D=24V		
	20				OPTIONAL POWERED INPUTS		
	24						048=48V
	28						110=110V
	32						
	36						
40							



**Eaton Electric Limited,**  
Great Marlings, Butterfield, Luton  
Beds, LU2 8DL, UK.  
Tel: + 44 (0)1582 723633 Fax: + 44 (0)1582 422283  
E-mail: rtkenquiry@eaton.com  
www.mtl-inst.com

© 2020 Eaton  
All Rights Reserved  
Publication No. EPS RTK UC625 Rev 5 160320  
March 2020

**EUROPE (EMEA):**  
+44 (0)1582 723633  
mtlenquiry@eaton.com

**THE AMERICAS:**  
+1 800 835 7075  
mtl-us-info@eaton.com

**ASIA-PACIFIC:**  
+65 6 645 9888  
sales.mtlsing@eaton.com

The given data is only intended as a product description and should not be regarded as a legal warranty of properties or guarantee. In the interest of further technical developments, we reserve the right to make design changes.